



ALL-IN-ONE SOLAR STREET LIGHT

# iSSL Maxi Area

MADE IN FRANCE



l'intelligence  
solaire solar  
intelligence

# iSSL Maxi Area



WARRANTY  
6 YEARS

MADE IN FRANCE

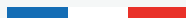

FUNCTION  
ANTI BLACKOUT



COMMUNICATION &  
REMOTE SUPERVISION



PLUG & PLAY



UNIQUE RESISTANCE  
TO EXTREME CLIMATES

iSSL Maxi Area is a reliable and robust all-in-one solar lighting solution particularly suitable for area lighting, car parks and public spaces. This innovative product offers very simple and quick installation (implemented in less than 10 minutes) with unparalleled performance and connected services.

The product is controlled through a monitoring service developed internally, the SunnAPP, and offers an optional motion detection feature.



1

## HORIZONTAL SOLAR PANELS

*Dedicated to tropical and temperate zones  
Self-cleaning coating  
No dust accumulation*

2

## HIGH-PERFORMANCE NiMH BATTERY

*Resistant to extreme conditions  
Long lifespan (average of 12 years)*

3

## SUNNACORE

*Electronic board with Bluetooth connection  
Intelligent energy management system to maximise  
battery life and optimise lighting all year round*

4

## HIGH-EFFICIENCY LED MODULE

*Tiltable from 0° to 30°  
Up to 175 lm/W*

5

## ANTI-VANDALISM

*Anti-theft screws (optional)*

## ■ MOTION DETECTOR

*(optional)*

- ☑ Lighting or increase in intensity upon detecting movement around the street light
- ☑ Preserves battery life
- ☑ Optimal energy consumption
- ☑ No light pollution
- ☑ Enhanced security

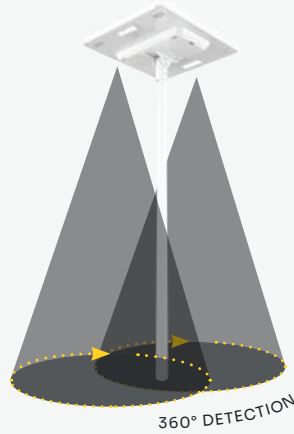

## ■ DATA SUPERVISION

### ☑ LOCAL SUNNAPP

*(included)*



Install your street lights and interact with your products via long-range Bluetooth.



Installation and commissioning support



Tracking and performance history



Registration and management of the park



Management of lighting profiles

### ☑ REMOTE SUNNA CLOUD

*(optional)*

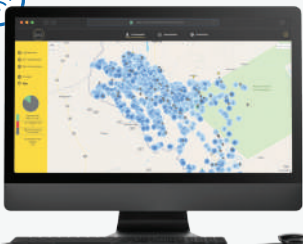

Monitor your street lights in real-time and perform preventive or curative maintenance on your products.

## ■ SMART ENERGY MANAGEMENT



Integrated into the iSSL range, the **SunnaCore** includes an advanced **autonomy management** feature that ensures enough energy in the battery to provide **optimal service 365 nights a year**, even in periods of low solar irradiation.

## ■ CUSTOMIZED LIGHTING PROFILES

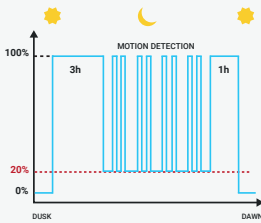

Our lighting profiles are optimized based on daily sunlight.

Based on previous days' weather data and the available battery capacity, our system automatically regulates light intensity to prevent outages and optimize lighting availability.

## ■ COLOR TEMPERATURES



## ■ LIGHT DISTRIBUTION

### NARROW ROAD

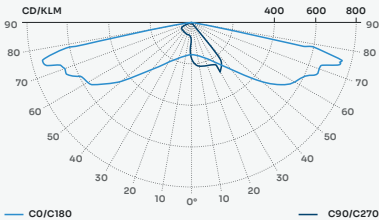

### MEDIUM ROAD

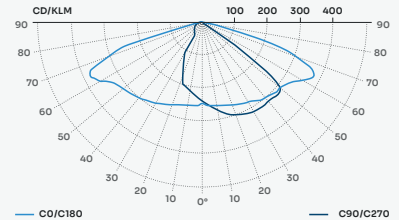

### AREA & WIDE ROAD

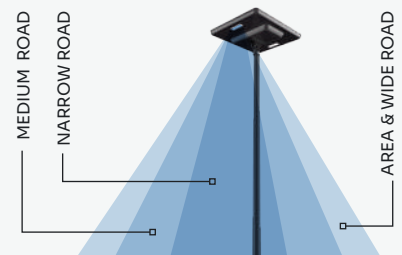
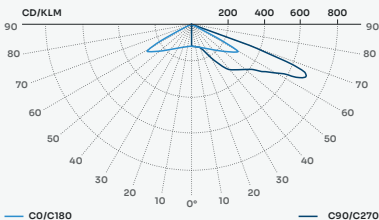

IP65	IK07(PV)	IK08	CE
------	----------	------	----

LIGHTING	LED Module	High-efficiency LEDs - Multichip technology (IP 67)
	Luminous Flux	3,600 to 7,200* lumens
	Power consumption	20 W to 40* W
	Luminous efficiency <i>(after optical losses)</i>	Up to 175 lm/W (4000 K / 5700 K)
	Color temperature	2700 K, 3000 K, 4000 K & 5700 K
	Lifetime	50,000 hours certified by IESNA LM-80 TM-21
	Certificates	EN 13032-1; EN 13032-2; EN 13201; EN 60598-1; EN 62471
	SOLAR PANELS	Technology
Power		80 Wc (2 x 40 Wc)
Specifications electrical per panel		VOC : 23,04 V / VMPP : 18,72 V / ISC : 2,34 A / IMPP : 2,14 A / 36 cells
Panel dimensions		776 x 350 mm (30.55 x 13.77 in) (x2 solar panels)
Lifetime		> 25 years at 80% of initial power
Tilt		Horizontal (0°)
Structure		Frameless
Certificates		IEC 61215; IEC 61730 I and II
BATTERIE	Battery technology	NIMH Battery (High temperature resistant, maintenance-free)
	Voltage	24V
	Capacity	240 Wh
	Operating temperature	-40°C to +70°C (-40°F to 158°F)
	Lifetime	12 years
	Certificates	EN 62133
ELECTRONICS	Technology	SunnaCore®
	Communication	Bluetooth
	Input voltage	24V
	Open circuit voltage	45V
	Max charge and discharge current	5A
	Wiring	Marine quality used for all applications
	Electrical protection	Electronic fuse
	Lifetime	12 years
	Water resistance	IP65 with waterproof connectors
	Certificates	CE; EN61000; EN61547; EN55015; EN62493; EN 62479 EN300328; EN 301489-1
GENERAL	Materials	Body ABS PMMA (100% recycled) and aluminum
	SCx	0,147 m²
	Mounting	Top mount Ø60 mm
	Weight <i>(excluding pole)</i>	19 kg
	Options	Motion detector (detection radius: 3 to 5m depending on installation height) Anti-theft screws / Local or remote supervision

\* Available with motion detection

## PRODUCT CODIFICATION

CODE	COLOR T*	MOTION DETECTOR	LIGHTING PROFILE	COLOR (RAL)	OPTICS	OPTION
SD420 Maxi Area	2 2700K	0 No	0A 100% (3h) / 40% / 100% (1h)	0 White (RAL 9010)	0 Area & Wide Road	0 None
	3 3000K	1 Yes	0B 60% (dusk - dawn)	1 Grey brown (RAL 8019)	1 Medium Road	
	4 4000K		0C 100% (3h) / 20% + detection 100% / 100% (1h)	2 Black (RAL 9005)	2 Narrow Road	
	0 5700K		0E 100% (2h) / 30% / 100% (1h)			
			0G 100% (2h) / 20% + detection 100% / 100% (1h)			
			0L 20% + detection 100%			
			0M 100% (5h) / 40% / 100% (1h)			
			0N 100% (6h) / 0%			
			0Q 50% (3h) / 15% / 50% (1h)			
			0R [50% (3h) / 12% / 50% (1h)] + detection 100%			
			0T 50% (4h) / 0% / 50% (1h)			
			AC 20% + detection 100% (dusk - 23h) / 0% / 20% + detection 100% (5h - dawn)			
			AH 0% + detection 100%			
			AM 100% (dusk - 8:30PM) / 0% / 50% (5AM - dawn - 30min) / 100% (dawn - 30min - dawn)			
			AT 100% (4h) / 0%			
			AU 100% (dusk - 00:00) / 0% / 100% (5AM - dawn)			
			BB 100% (dusk - 11:30PM) / 0% / 100% (5:30AM - dawn)			
			BD 100% (dusk - 10PM) / 0% / 100% (6:30AM - dawn)			
			BG 100% (dusk - dusk + 2h) / 50% (dusk + 2h - 11:30PM) / 0% (11:30PM - 5:30AM) / 50% (5:30AM - dawn - 1h) / 100% (dusk - 1h - dawn)			
			BJ 50% (2h30) + detection 100% / 0% / 50% (2h30) + detection 100%			
			BK 100% (2h) / 30% (3h) / 0% / 30% (1h) / 100% (1h)			
			BS 100% (3h) / 0% / 100% (2h)			

## DIMENSIONS

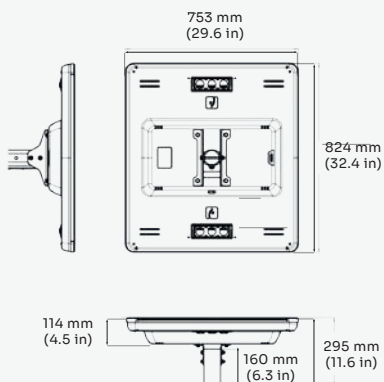

## COLORS



PARC & RECREATION



APPLICATIONS

PARKING LOT



PUBLIC AREA





2023



17 rue du Commandant Charcot  
33290 Blanquefort - FRANCE



[contact@sunna-design.com](mailto:contact@sunna-design.com)



[sunna-design.com](http://sunna-design.com)



SOLAR INTELLIGENCE